



КАТАЛОГ ПРОДУКЦИИ

☎ +7 (968) 787-787-4

✉ Frezy-almaz@yandex.ru

🌐 frezy-almaz.ru

📍 Пн.-Пт. с 9:00 до 18:00,
Сб.-Вс. — выходной.



ФРЕЗЫ

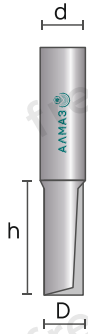
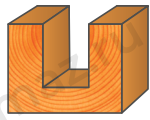

1000 Фреза пазовая прямая твердосплавная

D	H	d	Р
2	8	8MM	
3	12	8MM	
4	15	8MM	
5	18	8MM	
6	20	8MM	
7	30	8MM	
8	30	8MM	
10	30	8MM	
10	30	12MM	
12	30	8MM	

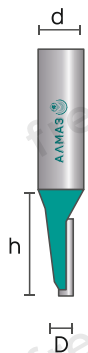

1001 Фреза пазовая прямая

D	H	d	Р
3	12	8MM	
4	12	8MM	
5	12	8MM	
6	12	8MM	

1003 Фреза пазовая прямая

D	H	d	Р
6	18	6MM	
8	25	6MM	
10	25	6MM	
12	30	6MM	
6	18	8MM	
7	30	8MM	
8	25	8MM	
10	25	8MM	
12	30	8MM	
14	30	8MM	
16	30	8MM	
18	30	8MM	
20	30	8MM	
22	30	8MM	
25	30	8MM	
30	40	12MM	
10	50	8MM	
12	50	8MM	
14	50	8MM	
10	40	12MM	
12	40	12MM	
14	40	12MM	
16	40	12MM	
18	40	12MM	
20	40	12MM	

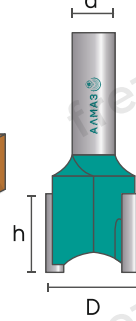
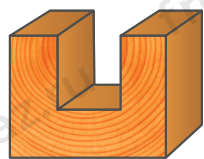
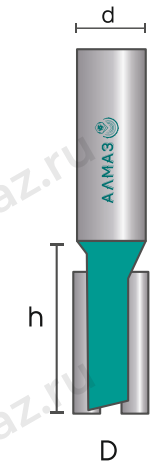

1002 Фреза пазовая прямая

D	H	d	Р
12	18	8MM	
14	20	8MM	
16	20	8MM	
18	20	8MM	
20	20	8MM	
22	20	8MM	
25	25	8MM	
30	25	8MM	

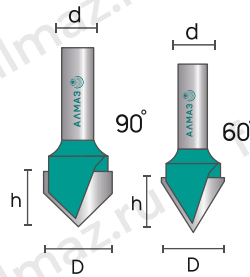

1004 Фреза пазовая галтельная V-form

a	D	H	d	Р
90°	10	10	8MM	
90°	12	12	8MM	
90°	16	16	8MM	
90°	25	25	8MM	
90°	32	32	8MM	
90°	35	25	12MM	NEW
90°	40	28	12MM	NEW
90°	45	30	12MM	NEW
60°	13	11	8MM	
60°	15	13	8MM	
60°	20	17	8MM	
120°	40	24	8MM	
150°	40	19	8MM	
90°	14	10	8MM	
135°	22	10	8MM	

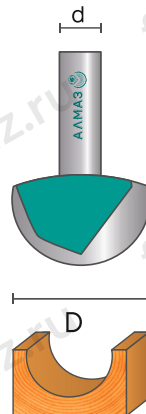
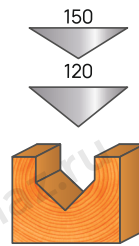

1005 Фреза пазовая галтельная

D	H	d	Р
6	4	8MM	
8	6	8MM	
10	7	8MM	
12	9	8MM	
16	11	8MM	
18	12	8MM	
22	14	8MM	
25	16	8MM	
30	20	8MM	
35	22	8MM	
40	25	12MM	
50	25	12MM	

1006 Фреза ласточкин хвост

D	H	d	Р
7,5	5	8MM	
10	10	8MM	
12	12	8MM	
16	16	8MM	
25	25	8MM	
25	25	12MM	

1007 Фреза пазовая прямая

I	D	H	d	L	Р
60	8	30	8MM	90	
60	9	30	8MM	90	
60	10	30	8MM	90	
60	11	30	8MM	90	
35	12	20	8MM	55	NEW
60	12	30	8MM	90	
100	12	30	8MM	130	
60	13	30	8MM	90	
35	14	20	8MM	55	NEW
60	14	30	8MM	90	
100	14	30	8MM	130	
60	15	30	8MM	90	
35	16	20	8MM	55	NEW
60	16	30	8MM	90	
100	16	30	8MM	130	
60	17	30	8MM	90	
60	18	30	8MM	90	
60	19	30	8MM	90	
100	22	30	8MM	90	
60	23	30	8MM	90	
100	24	30	8MM	130	
40	25	16	8MM	56	
40	26	20	8MM	60	
40	27	20	8MM	60	
40	28	20	8MM	60	
40	30	16	8MM	56	
40	40	16	12MM	56	
55	50	25	12MM	80	
80	14	40	12MM	120	
100	16	30	12MM	130	
80	18	40	12MM	120	
80	21	40	12MM	120	
54	12	76	12MM	130	
54	14	76	12MM	130	
54	16	76	12MM	130	
54	18	76	12MM	130	

1007 Rapira 2+1

I	D	H	d	L	Р
65	12	15	8MM	80	
65	14	15	8MM	80	
65	16	15	8MM	80	

1007 Spiral

I	D	H	d	L	Р
100	12	30	12MM	130	
100	14	30	12MM	130	
100	16	30	12MM	130	

1009 Фреза пазовая фасонная

R	D	H	d	Р
4	16	10	8MM	
6	18	12	8MM	
8	25	16	8MM	
10	30	18	8MM	
12	32	22	8MM	
16	35	25	8MM	

1008 Фреза фальцевая

D	H	d	Р
33	2	8MM	
33	3	8MM	
33	4	8MM	
33	5	8MM	
33	6	8MM	
33	8	8MM	
33	10	8MM	
33	12	8MM	
33	16	8MM	

1008 z4 Фреза фальцевая для слэбов

D	H	d	Р
52	12	8MM	

1010 Фреза пазовая галтельная

R	D	H	d	Р
5	10	9	8MM	
8	16	15	8MM	
10	20	19	8MM	
12	24	22	8MM	
15	30	27	8MM	

ФРЕЗЫ

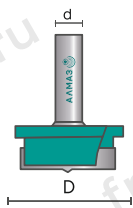

1011 st Фреза ФОРСТНЕРА

D	H	d	Р
35	12	8MM	

1011 Фреза ФОРСТНЕРА

D	H	d	Р
15	18	8MM	
16	18	8MM	
18	18	8MM	
20	18	8MM	
22	18	8MM	
25	18	8MM	
26	18	8MM	
28	18	8MM	
30	18	8MM	
32	18	8MM	
35	18	8MM	
40	18	8MM	
45	18	8MM	
50	18	8MM	
55	18	12MM	
60	18	12MM	

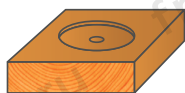
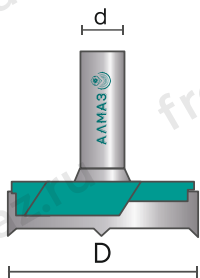

1011 z3 Фреза ФОРСТНЕРА

D	H	d1	d2	L	Р
35	12,5	8MM	12MM	90	
65	12,5	8MM	12MM	90	
68	12,5	8MM	12MM	90	
70	12,5	8MM	12MM	90	



1011 LONG Фреза ФОРСТНЕРА удлиненная

D	H	d1	d2	L	Р
15	18	8MM	8MM	90	
16	18	8MM	8MM	90	
18	18	8MM	10MM	90	
20	18	8MM	10MM	90	
22	18	8MM	10MM	90	
25	18	8MM	12MM	90	
26	18	8MM	12MM	90	
28	18	8MM	12MM	90	
30	18	8MM	12MM	90	
32	18	8MM	12MM	90	

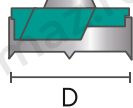

1012 Фреза пазовая галтельная

l	D	H	d	L	Р
35	6	20	8MM	55	
35	8	25	8MM	60	
35	10	25	8MM	60	
35	12	25	8MM	60	
35	14	25	8MM	60	
35	16	25	8MM	60	
35	18	30	8MM	65	
35	20	30	8MM	65	
35	25	30	8MM	65	

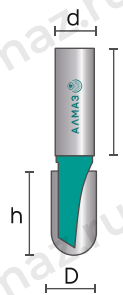

1013 Фреза кромочная полустержневая

R	D	H	d	Р
10	24	24	8MM	
16	26	30	8MM	
20	28	36	8MM	
32	28	47	12MM	

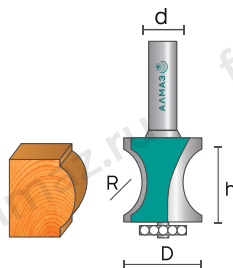

1014 Фреза полустержневая

R	D	H	d	Р
3	24	6	8MM	
5	27	10	8MM	
6	30	12	8MM	
8	32	16	8MM	
10	35	20	8MM	
12	40	24	8MM	
14	48	28	12MM	
16	52	32	12MM	

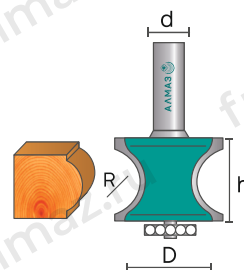

1015 Фреза кромочная галтельная

R	D	H	d	Р
3	20	6	8MM	
5	24	10	8MM	
6	27	12	8MM	
8	30	16	8MM	
10	33	20	8MM	
12	38	24	8MM	

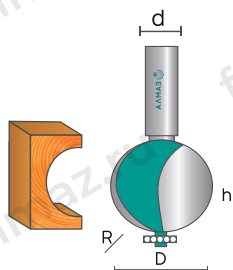

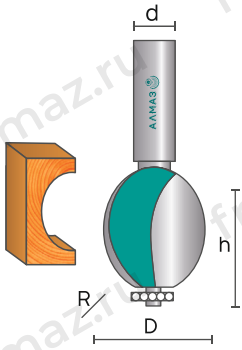

1016 Фреза кромочная галтельная

R	D	H	d	Р
10	21	16	8MM	
16	25	25	8MM	
20	25	28,6	8MM	
32	26	38	8MM	

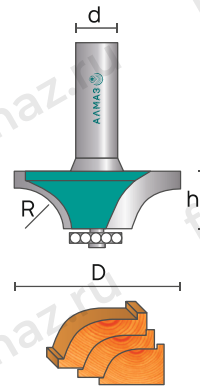

1019 Фреза кромочная калёвочная

R	D	H	d	Р
5	22	10	8MM	
6	25	11	8MM	
8	28	12	8MM	
10	30	16	8MM	
12	37	18	8MM	
16	45	20	8MM	

1017 Фреза кромочная калёвочная

R	D	H	d	Р
1	12	3	6MM	
2	16	5	6MM	
3	18	6	6MM	
4	20	8	6MM	
5	22	10	6MM	
6	25	11	6MM	
1	12	5	8MM	
1,5	13	5	8MM	
2	16	5	8MM	
3	18	6	8MM	
4	20	8	8MM	
5	22	10	8MM	
6	25	11	8MM	
8	28	12	8MM	
10	30	16	8MM	
12	35	18	8MM	
14	38	20	8MM	
16	42	22	8MM	
18	50	25	8MM	
20	53	25	12MM	
25	63	32	12MM	
30	73	37	12MM	

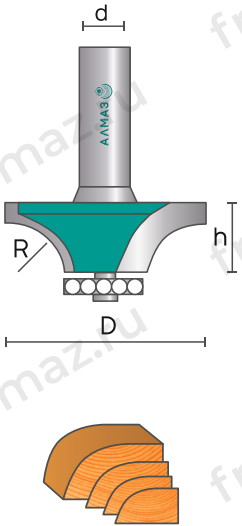

1020 Фреза кромочная прямая

D	H	d	Р
6	18	6MM	NEW
8	20	6MM	NEW
10	25	6MM	NEW
6	18	8MM	
8	20	8MM	NEW
10	12	8MM	
10	25	8MM	
12	25	8MM	
12	30	8MM	
14	30	8MM	
16	30	8MM	
12	40	8MM	
14	40	8MM	
16	40	8MM	
10	50	8MM	
12	50	8MM	
14	50	8MM	

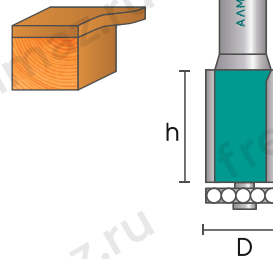

1018 Фреза кромочная калёвочная

R	D	H	d	Р
5	22	10	8MM	
6	25	11	8MM	
8	29	12	8MM	
10	30	16	8MM	
12	35	18	8MM	
16	42	20	8MM	
18	49	22	8MM	
20	53	24	12MM	
25	63	28,4	12MM	
30	73	34	12MM	

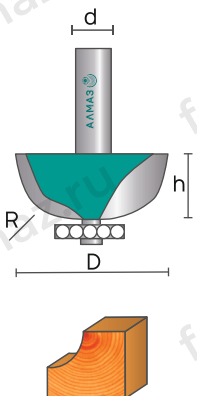

1020 2В Фреза кромочная прямая

D	H	d	Р
16	30	8MM	NEW
16	40	8MM	NEW
16	50	8MM	NEW
19	40	12MM	NEW
19	50	12MM	NEW
19	60	12MM	NEW

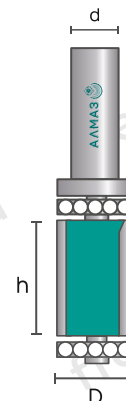

ФРЕЗЫ

1020 z4 Фреза кромочная прямая

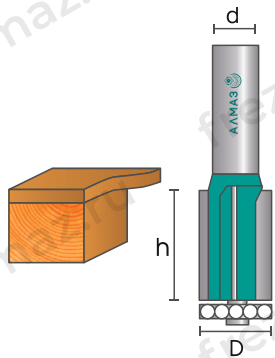

D	H	d	Р
12	30	8MM	
14	30	8MM	
16	40	8MM	
16	50	8MM	
19	50	12MM	
19	60	12MM	
21	50	12MM	
21	60	12MM	

1020 z6 Фреза кромочная прямая

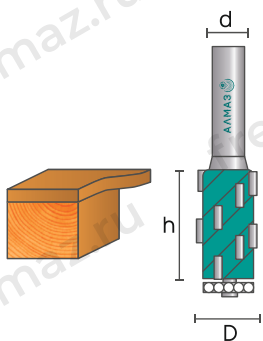

D	H	d	Р
21	50	12MM	
21	60	12MM	

1021 Фреза кромочная прямая

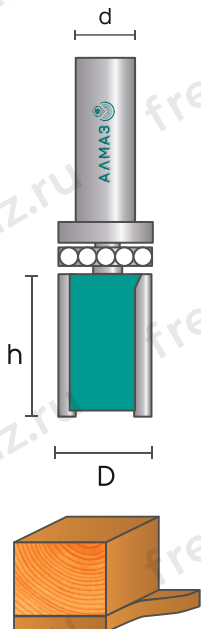

D	H	d	Р
12	20	6MM	NEW
14	20	6MM	NEW
16	20	6MM	NEW
6	19	8MM	
12	20	8MM	
12	30	8MM	
12	40	8MM	
12	50	8MM	
14	20	8MM	
14	30	8MM	
14	40	8MM	
14	50	8MM	
16	20	8MM	
16	30	8MM	
16	40	8MM	
19	30	8MM	
19	40	8MM	
21	40	12MM	
21	50	12MM	

1021 z4 Фреза кромочная прямая

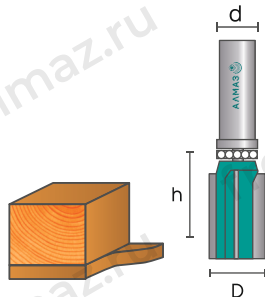

D	H	d	Р
16	40	8MM	
16	50	8MM	
21	40	12MM	
21	50	12MM	
21	60	12MM	

1021 z6 Фреза кромочная прямая

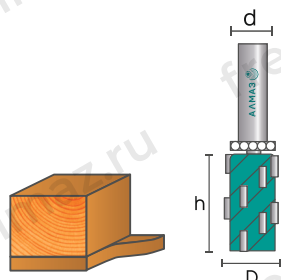

D	H	d	Р
21	50	12MM	
21	60	12MM	

1022 Фреза кромочная конусная

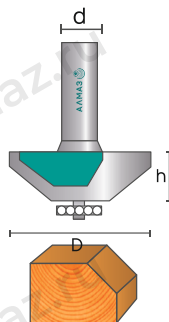

a	D	H	d	Р
45°	25	10	8MM	
45°	30	12	8MM	
45°	35	16	8MM	
45°	40	18	8MM	
45°	40	18	12MM	

1023 Фреза кромочная фальцевая

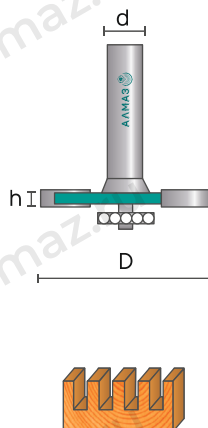

l	D	H	d	Р
50	33	2	8MM	
50	33	2,5	8MM	
50	33	3	8MM	
50	33	4	8MM	
50	33	5	8MM	
50	33	6	8MM	
50	33	8	8MM	
50	33	10	8MM	
35	33	12	8MM	
35	33	14	8MM	
35	33	16	8MM	
35	33	18	8MM	
35	33	20	8MM	
35	33	25	8MM	
35	33	30	12MM	
35	33	40	12MM	
40	56	5	8MM	
40	56	10	8MM	
40	66	5	12MM	
40	66	10	12MM	

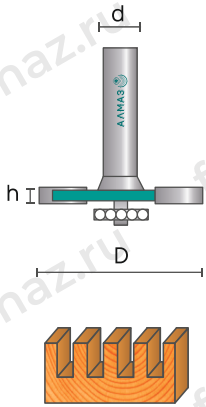
1023 z3 Фреза кромочная фальцевая

L	D	H	d	Ф
50	40	2	8MM	
50	40	3	8MM	
50	40	4	8MM	
50	40	5	8MM	
50	40	6	8MM	
50	40	8	8MM	
50	40	10	8MM	

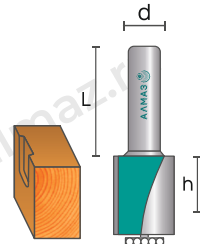
1120 Фреза кромочная прямая

D	H	d	L	Ф
20	30	8MM	35	
20	40	8MM	35	

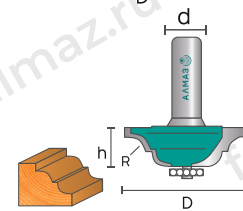
2001 Фреза кромочная калёвочная

R	D	H	d	Ф
4	33	12	8MM	
6	40	16	8MM	
8	50	20	8MM	

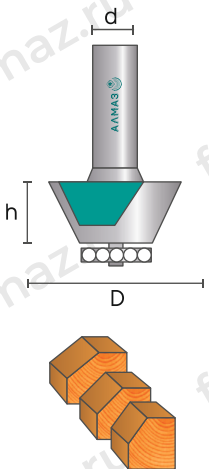
1024 Фреза кромочная конусна

a	D	H	d	Ф
15°	24	22	8MM	
22,5°	31	23	8MM	
30°	38	23	8MM	
45°	48	22,5	8MM	
45°	48	22,5	12MM	
60°	53	16	8MM	
75°	63	12	8MM	
60°	73	22	12MM	
75°	83	15	12MM	
80°	93	15	12MM	

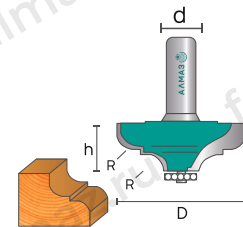
2002 Фреза кромочная калёвочная

R	D	H	d	Ф
4	30	12	8MM	
6	38	16	8MM	
8	45	20	8MM	

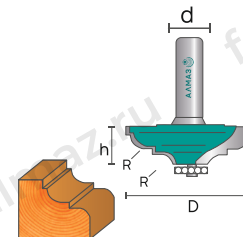
2003 Фреза кромочная калёвочная

R	D	H	d	Ф
4	32	14	8MM	
6	40	18	8MM	
8	50	22	8MM	

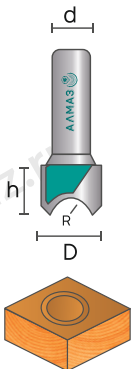
1026 Фреза фасонная

R	D	H	d	Ф
3	10	10	8MM	
5	16	15	8MM	
8	24	20	8MM	
10	30	25	8MM	
12	36	30	8MM	

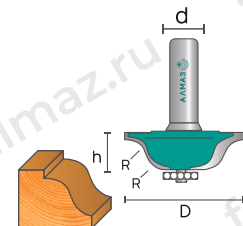
2004 Фреза кромочная калёвочная

R	D	H	d	Ф
4	30	12	8MM	
6	38	16	8MM	
8	45	20	8MM	

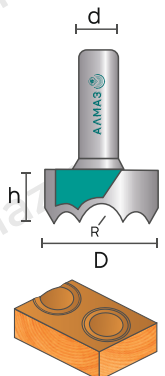
1027 Фреза фасонная

R	D	H	d	Ф
3	24	12	8MM	
4	28	14	8MM	
5	32	16	8MM	
6	36	18	8MM	
8	40	22	8MM	

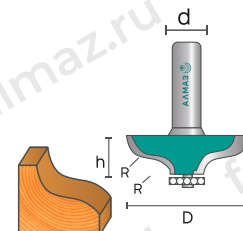
2005 Фреза кромочная калёвочная

R	D	H	d	Ф
4	30	12	8MM	
6	38	16	8MM	
8	45	20	8MM	

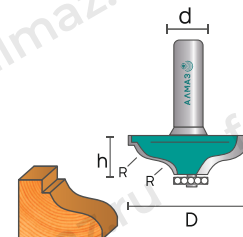

2006 Фреза кромочная калёвочная

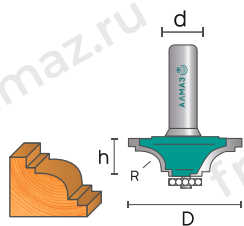
R	D	H	d	Ф
4	33	12	8MM	
6	40	16	8MM	
8	50	20	8MM	

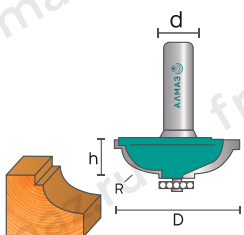

2007 Фреза кромочная калёвочная

R	D	H	d	Ф
6	33	14	8MM	
8	38	16	8MM	
10	42	18	8MM	



2008 Фреза кромочная калёвочная

R	D	H	d	Ф
6	30	12	8MM	
8	33	14	8MM	
10	38	16	8MM	
12	43	18	8MM	

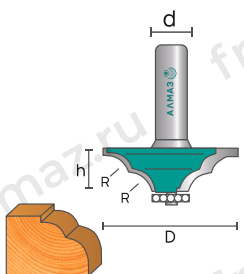

2009 Фреза кромочная калёвочная

R	D	H	d	Ф
4	30	12	8MM	
6	38	14	8MM	
8	45	18	8MM	

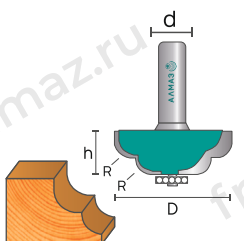

2010 Фреза кромочная калёвочная

R	D	H	d	Ф
4	30	10	8MM	
6	38	14	8MM	
8	45	18	8MM	

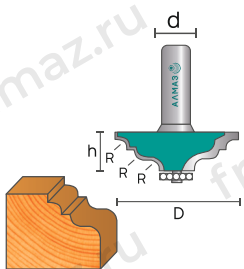

2011 Фреза кромочная калёвочная

R	D	H	d	Ф
4	41	16	8MM	
6	52	22	8MM	

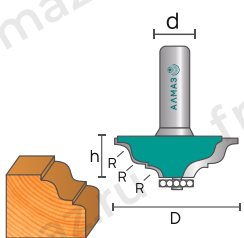

2012 Фреза кромочная калёвочная

R	D	H	d	Ф
4	38	16	8MM	
6	50	22	8MM	

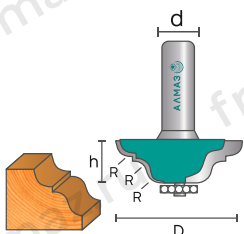

2013 Фреза кромочная калёвочная

R	D	H	d	Ф
4	38	16	8MM	
6	50	22	8MM	

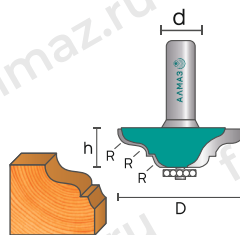

2014 Фреза кромочная калёвочная

R	D	H	d	Ф
4	40	14	8MM	
6	53	20	8MM	

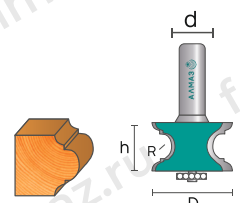

2015 Фреза кромочная фигурная

R	D	H	d	Ф
3	28	18	8MM	
4	33	22	8MM	
5	38	26	8MM	

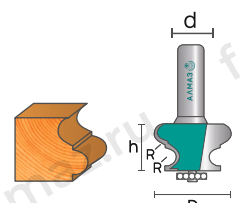

2019 Фреза кромочная мультипрофильная

R	D	H	d	Ф
4	32	20	8MM	
6	40	30	8MM	

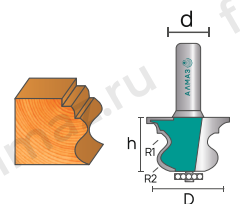

2020 Фреза кромочная мультипрофильная

R	D	H	d	Ф
3/6	30	25	8MM	
4/8	35	32	8MM	

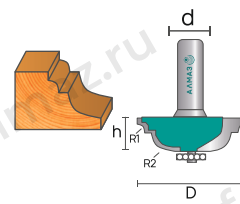

2021 Фреза кромочная калёвочная

R	D	H	d	Ф
3/8	40	15	8MM	
4/10	46	18	8MM	

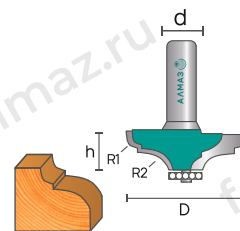

2022 Фреза кромочная калёвочная

R	D	H	d	Ф
3/8	36	15	8MM	
4/10	43	18	8MM	

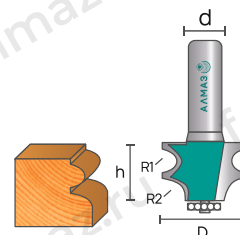

2025 Фреза кромочная фигурная

R	D	H	d	Ф
4/6	25	20	8MM	
6/8	30	25	8MM	
8/10	33	32	8MM	

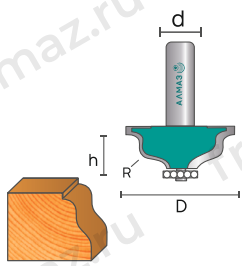

2029 Фреза кромочная калёвочная

R	D	H	d	Ф
3	30	12	8MM	
4	38	15	8MM	
6	50	22	8MM	

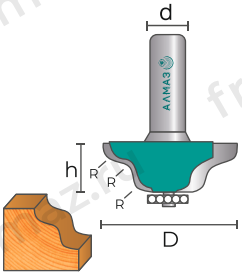

2030 Фреза кромочная калёвочная

R	D	H	d	Ф
3	30	12	8MM	
4	38	15	8MM	
6	50	22	8MM	

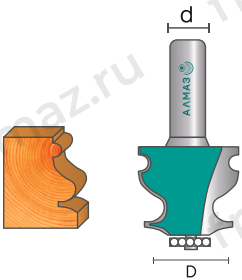

2034 Фреза кромочная фигурная

D	H	d	Ф
18	25	8MM	
24	35	8MM	
27	42	12MM	

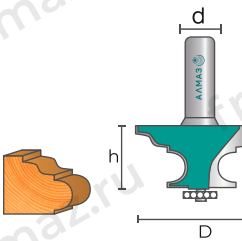

2036 Фреза кромочная фигурная

D	H	d	Ф
34	16	8MM	
38	20	8MM	
44	24	12MM	

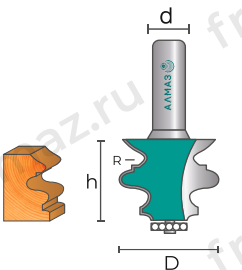

2037 Фреза кромочная фигурная

R	D	H	d	Ф
1,5	25	25	8MM	
3	30	30	8MM	
4	35	35	12MM	

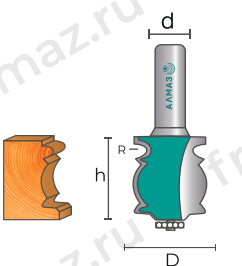

2038 Фреза кромочная фигурная

R	D	H	d	Ф
4	25	35	8MM	
5	30	40	12MM	

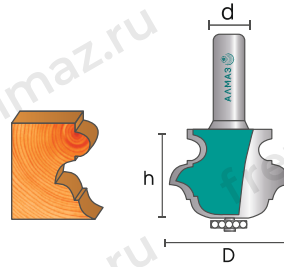

2040 Фреза кромочная мультипрофильная

D	H	d	Ф
38	28	8MM	
48	38	12MM	
57	48	12MM	

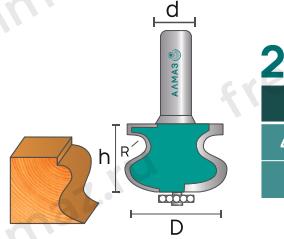

2044 Фреза профильная

R	D	H	d	Ф
4,8	29	20	8MM	NEW
6	38,1	20,7	8MM	

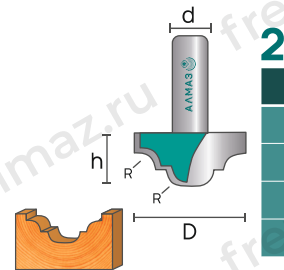

2051 Фреза пазовая фасонная

R	D	H	d	Ф
3	16	10	8MM	
4	22	12	8MM	
6	28	15	8MM	
8	36	20	8MM	

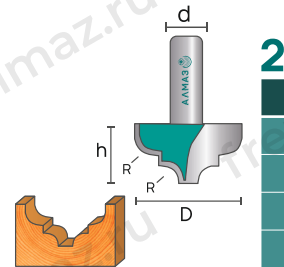

2052 Фреза пазовая фасонная

R	D	H	d	Ф
3	15	10	8MM	
4	20	12	8MM	
5	25	15	8MM	
6	30	20	8MM	

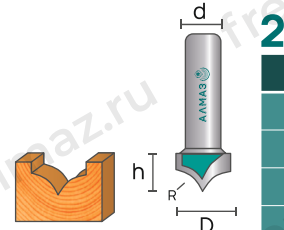

2053 Фреза пазовая фасонная

R	D	H	d	Ф
3	6	7	8MM	
5	10	9	8MM	
8	16	11	8MM	
10	19	13	8MM	

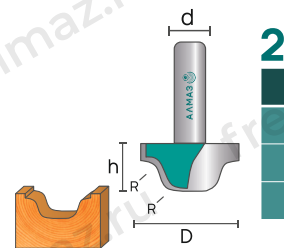

2054 Фреза пазовая фасонная

R	D	H	d	Ф
3	15	10	8MM	
4	20	12	8MM	
5	22	15	8MM	

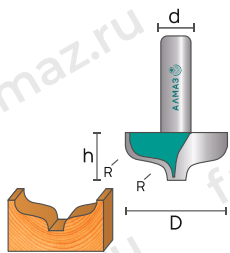

2055 Фреза пазовая фасонная

R	D	H	d	Ф
3	15	10	8MM	
4	20	12	8MM	
5	25	15	8MM	

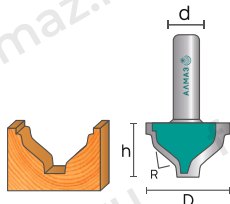

2056 Фреза пазовая фасонная

R	D	H	d	Ф
6	24	14	8MM	
8	28	18	8MM	

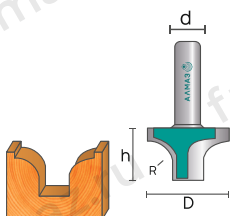

2057 Фреза пазовая фасонная

R	D	H	d	Ф
6	19	10	8MM	
8	22	14	8MM	
10	24	18	8MM	
12	28	22	8MM	

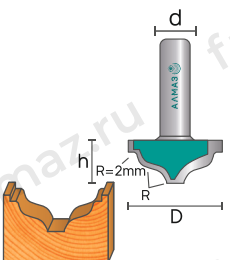

2059 Фреза пазовая фасонная

R	D	H	d	Ф
3	19	12	8MM	
4	24	15	8MM	

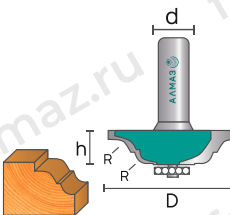

2101 Фреза фигурная горизонтальная

R	D	H	d	Ф
4	33	8	8MM	
6	40	10	8MM	
8	50	12	8MM	

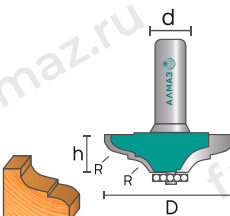

2102 Фреза фигурная горизонтальная

R	D	H	d	Ф
4	33	8	8MM	
6	38	10	8MM	
8	45	12	8MM	

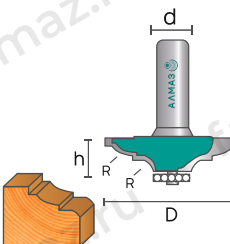

2103 Фреза фигурная горизонтальная

R	D	H	d	Ф
4	32	8	8MM	
6	40	10	8MM	
8	50	12	8MM	

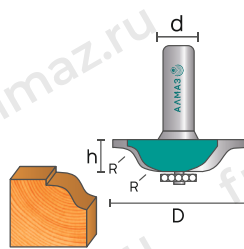

2104 Фреза фигурная горизонтальная

R	D	H	d	Ф
4	30	8	8MM	
6	38	10	8MM	
8	45	12	8MM	

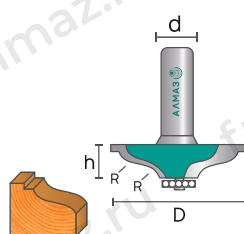

2106 Фреза фигурная горизонтальная

R	D	H	d	Ф
4	33	8	8MM	
6	40	10	8MM	
8	50	12	8MM	

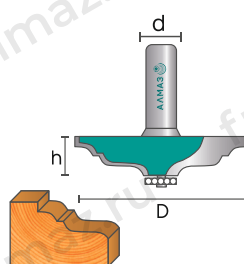

2111 Фреза фигурная горизонтальная

R	D	H	d	Ф
3	40	8	8MM	
4	50	12	8MM	
5	63	16	12MM	

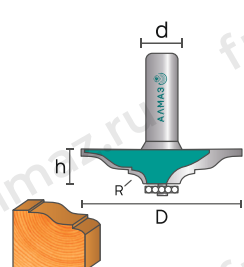

2112 Фреза фигурная горизонтальная

R	D	H	d	Ф
3	40	12	8MM	
4	50	15	8MM	
5	63	19	12MM	

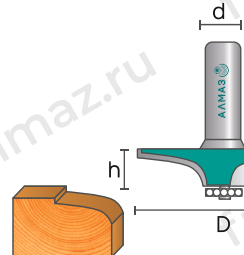

2117 Фреза фигурная горизонтальная

D	H	d	Ф
40	12	8MM	
50	15	8MM	
64	17	12MM	

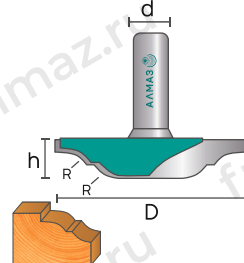

2151 Фреза фигурная горизонтальная

R	D	H	d	Ф
3	22	6	8MM	
4	28	8	8MM	
5	34	10	8MM	

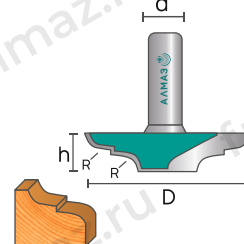

2152 Фреза фигурная горизонтальная

R	D	H	d	Ф
3	22	6	8MM	
4	28	8	8MM	
5	34	10	8MM	

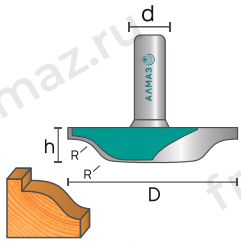

2154 Фреза фигурейная горизонтальная

R	D	H	d	Р
3	22	6	8MM	
4	28	8	8MM	
5	34	10	8MM	

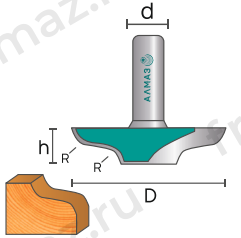

2155 Фреза фигурейная горизонтальная

R	D	H	d	Р
3	22	6	8MM	
4	28	8	8MM	
5	34	10	8MM	

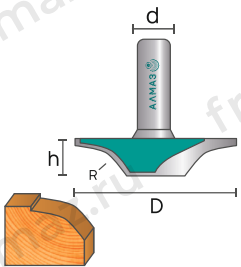

2156 Фреза фигурейная горизонтальная

R	D	H	d	Р
6	22	6	8MM	
8	28	8	8MM	
10	34	10	8MM	

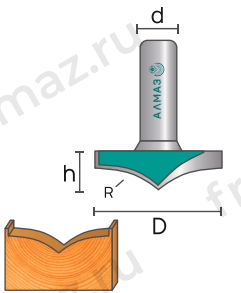

2157 Фреза фигурейная горизонтальная

R	D	H	d	Р
20	16	8	8MM	
20	22	9	8MM	
20	28	11	8MM	
20	34	12	8MM	
25	40	13	8MM	
30	50	14	8MM	

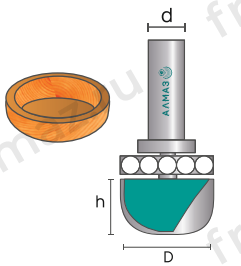

2166 Фреза пазовая фасонная для изготовления чаш, менажниц

R	D	H	d	Р
6	19	10	8MM	NEW
6	24	10	8MM	NEW
6	28	10	8MM	NEW
6	32	10	12MM	NEW

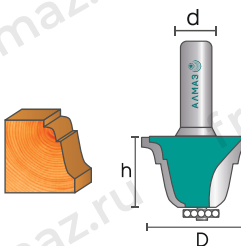

2201 Фреза кромочная фигурейная

D	H	d	Р
30	25	8MM	
35	30	8MM	

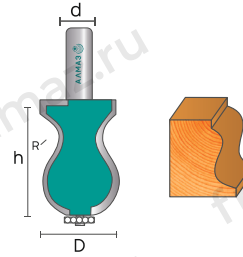

2204 Фреза кромочная фигурейная

D	H	d	Р
32	50	12MM	

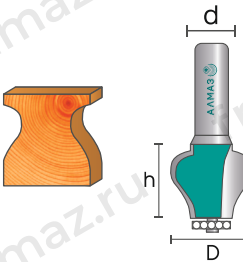

2205 Фреза кромочная фигурейная

D	H	d	Р
25	30	8MM	
30	35	8MM	
35	40	12MM	

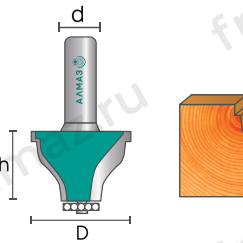

2206 Фреза кромочная фигурейная

D	H	d	Р
30	25	8MM	
35	30	8MM	

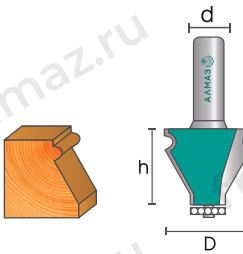

2207 Фреза кромочная фигурейная

D	H	d	Р
32	35	8MM	
35	38	12MM	

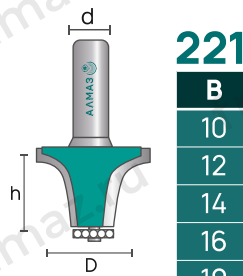

2217 Фреза кромочная фигурейная

B	R	D	H	d	Р
10	6	33	20	8MM	
12	8	37	22	8MM	
14	10	41	24	8MM	
16	12	45	26	8MM	
19	14	51	28	8MM	
21	16	55	30	12MM	
22	18	57	32	12MM	

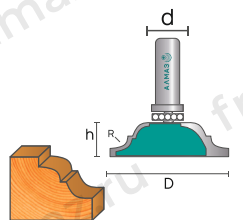

2301 Фреза кромочная калёвочная

R	D	H	d	Р
4	40	12	8MM	
6	48	16	8MM	
6	55	16	12MM	

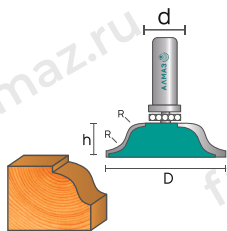

2304 Фреза кромочная калёвочная

R	D	H	d	Ф
4	35	12	8MM	
6	43	16	8MM	
6	52	16	12MM	

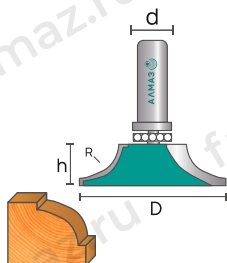

2307 Фреза кромочная калёвочная

R	D	H	d	Ф
8	42	12	8MM	
10	46	16	8MM	
12	50	18	8MM	
16	68	20	12MM	

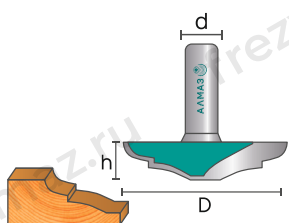

2402 Фреза пазовая фасонная

D	H	d	Ф
40	8	8MM	
50	12	8MM	
60	16	12MM	

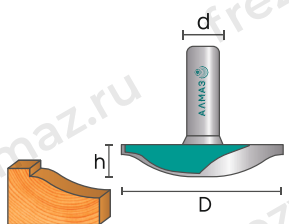

2404 Фреза пазовая фасонная

D	H	d	Ф
40	5	8MM	
50	7	8MM	
60	9	12MM	

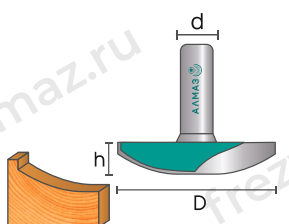

2405 Фреза пазовая фасонная

D	H	d	Ф
40	10	8MM	
50	11	8MM	
60	12	12MM	

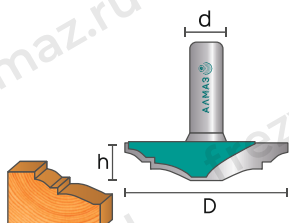

2412 Фреза пазовая фасонная

D	H	d	Ф
40	7	8MM	
50	8	8MM	
60	9	12MM	

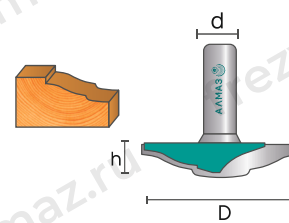

2416 Фреза пазовая фасонная

D	H	d	Ф
40	7	8MM	
50	9	8MM	
60	11	12MM	

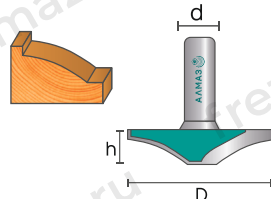

2417 Фреза пазовая фасонная

D	H	d	Ф
40	7	8MM	
50	9	8MM	
60	11	12MM	

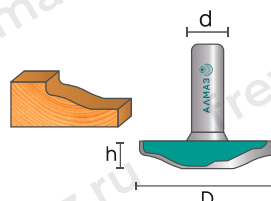

2430 Фреза пазовая фасонная

D	H	d	Ф
40	8	8MM	
50	12	8MM	
60	16	12MM	

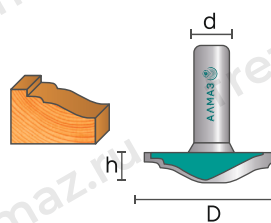

2433 Фреза пазовая фасонная

D	H	d	Ф
40	10	8MM	
50	11	8MM	
60	12	12MM	

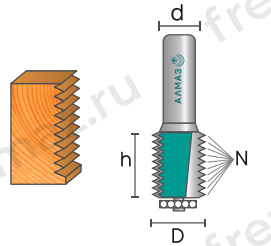

2500 Фреза микрошип

N	H	d	Ф
6	24	8MM	
5	30	8MM	
10	40	8MM	
9	54	12MM	
8	54	12MM	

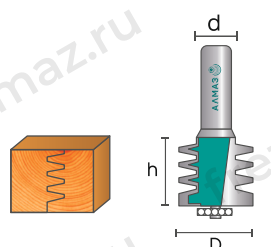

2501 Фреза микрошип

D	H	d	Ф
33	40	8MM	
33	50	12MM	

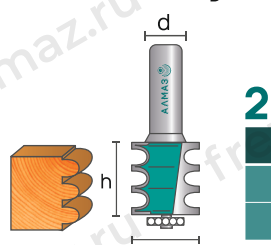

2502 Фреза кромочная фигурная

R	D	H	d	Ф
3	22	25	8MM	
4	30	35	8MM	

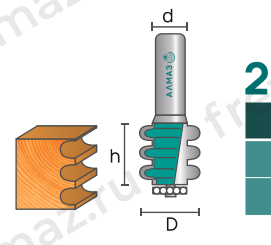

2503 Фреза кромочная фигурная

R	D	H	d	Ф
3	22	25	8MM	
4	30	35	8MM	

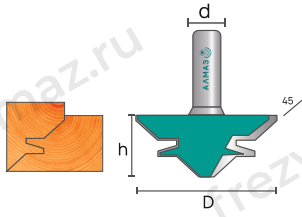

2510 Фреза комбинированная универсальная

D	H	d	Ф
50	22	8MM	
50	22	12MM	

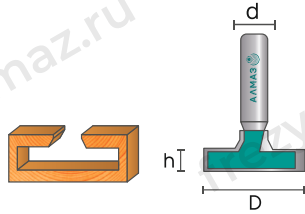

2511 Фреза конструкционная Т-обр.

D	H	d	Ф
30	17,5	8MM	

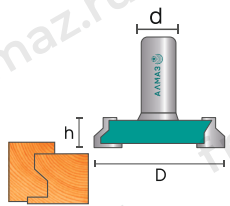

2512 Фреза пазовая конструкционная Т-обр.

T	D	H	d	Ф
10-16	25	13	8MM	
16-25	32	13	8MM	

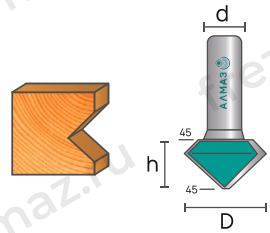

2515 Фреза кромочная конусная

D	H	d	Ф
35	22	8MM	
48	30	12MM	

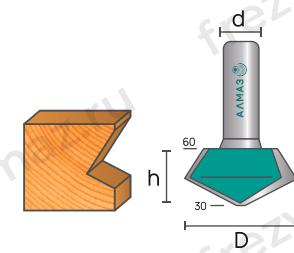

2516 Фреза кромочная конусная

D	H	d	Ф
45	22	8MM	
68	30	12MM	

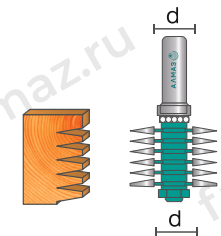

2550 Фреза микрошип

Z	D	H	d	Ф
2	48	40	12MM	

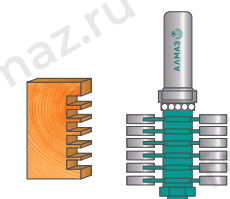

2560 Фреза микрошип

Z	D	H	d	Ф
3	48	40	12MM	

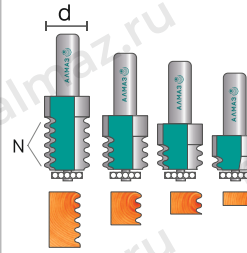

2600 Фреза микрошип

N	D	H	d	Ф
1	21	19	8MM	
2	21	24	8MM	
3	21	30	8MM	
4	21	40	12MM	

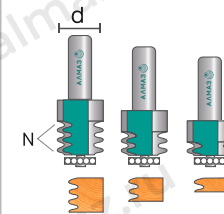

2601 Фреза микрошип

N	D	H	d	Ф
1	30	25	8MM	
2	30	35	8MM	
3	30	40	12MM	

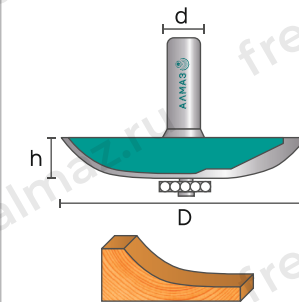

3001 Фреза фигурейная горизонтальная

D	H	d	Ф
73	12	8MM	
83	13	12MM	
93	14	12MM	
103	15	12MM	

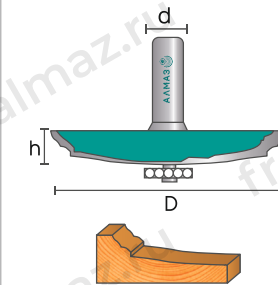

3002 Фреза фигурейная горизонтальная

D	H	d	Ф
73	12	8MM	
83	13	12MM	
93	14	12MM	
103	15	12MM	

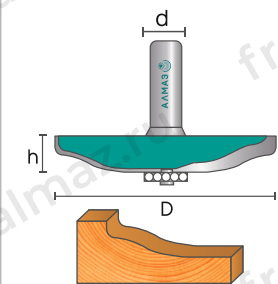

3003 Фреза фигурейная горизонтальная

D	H	d	Ф
73	12	8MM	
83	13	12MM	
93	14	12MM	
103	15	12MM	

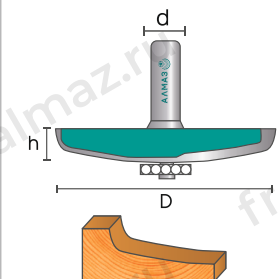

3005 Фреза фигурейная горизонтальная

D	H	d	Ф
73	12	8MM	
83	13	12MM	
93	14	12MM	
103	15	12MM	

ФРЕЗЫ

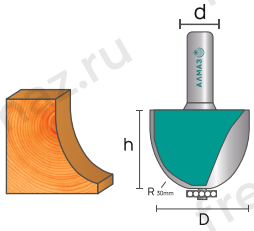

3011 Фреза фигурейная вертикальная

D	H	d	Ф
42	50	12MM	

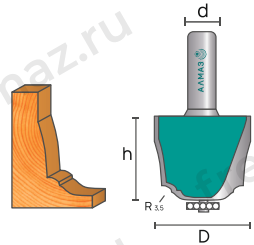

3012 Фреза фигурейная вертикальная

D	H	d	Ф
42	50	12MM	

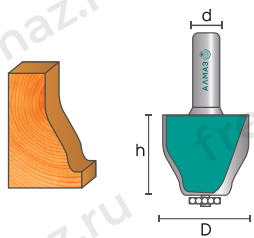

3013 Фреза фигурейная вертикальная

D	H	d	Ф
42	50	12MM	

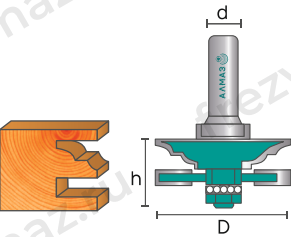

3501 Фреза комбинированная рамочная

D	H	d	Ф
42	20	8MM	

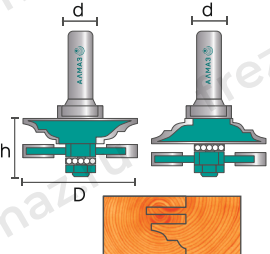

3501 set Фреза рамочная

D	H	d	Ф
46	24	8MM	
46	24	12MM	

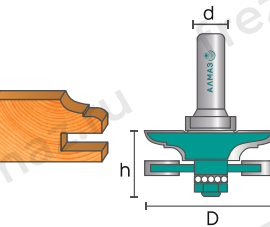

3502 Фреза комбинированная рамочная

D	H	d	Ф
42	20	8MM	

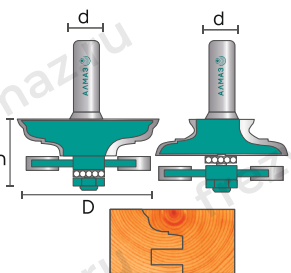

3502 set Фреза рамочная

D	H	d	Ф
46	24	8MM	
46	24	12MM	

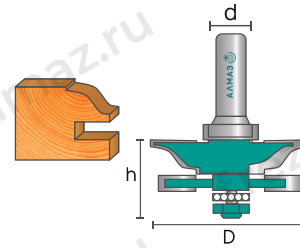

3504 Фреза комбинированная рамочная

D	H	d	Ф
42	20	8MM	

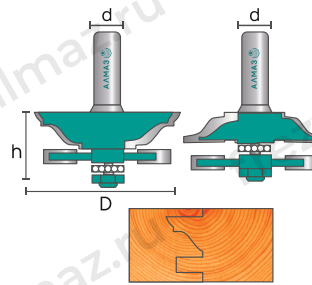

3504 set Фреза рамочная

D	H	d	Ф
46	24	8MM	
46	24	12MM	

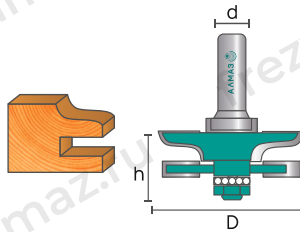

3505 Фреза комбинированная рамочная

D	H	d	Ф
42	20	8MM	

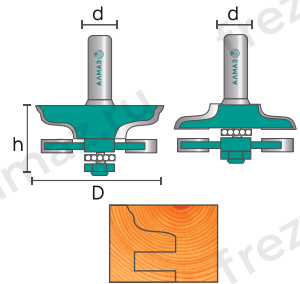

3505 set Фреза рамочная

D	H	d	Ф
46	24	8MM	
46	24	12MM	

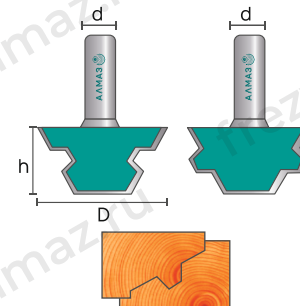

3510 set Фреза для срашивания

D	H	d	Ф
37	22	8MM	
44	30	12MM	

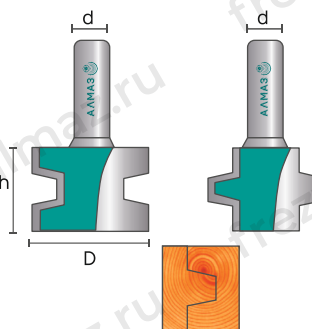

3511 set Фреза паз-шип

D	H	d	Ф
28	25	8MM	
32	32	12MM	

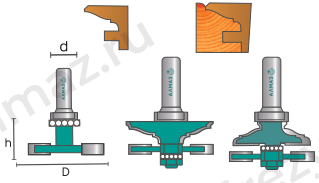

3512 set Набор рамочных фрез

D	H	d	Ф
60	24	12MM	NEW

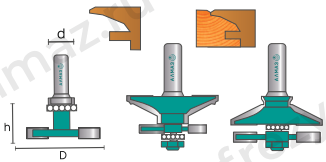

3515 set Набор рамочных фрез

D	H	d	Ф
60	24	12MM	NEW

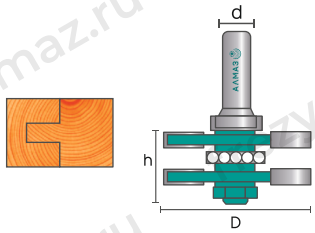

3523 Фреза комбинированная паз-шип

D	H	d	Ф
40	20	8MM	
46	20	12MM	

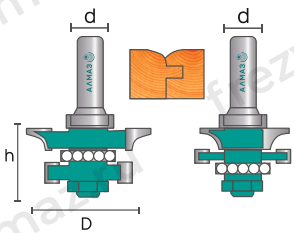

3550 set Фреза для изготовления вагонки

D	H	d	Ф
38	21	8MM	

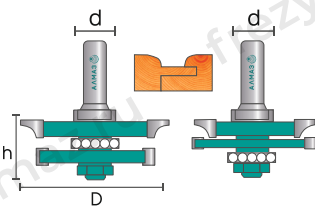

3551 set Фреза для изготовления вагонки

D	H	d	Ф
50	21	12MM	

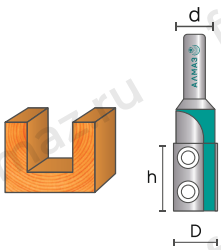

107 Фреза со сменными пластинами прямая

Z	D	H	d	Ф
2	16	30	8MM	
2	16	40	8MM	

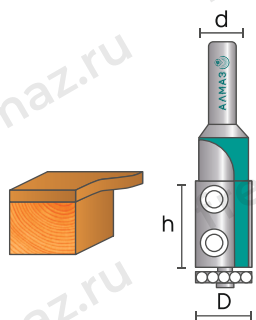

120 Фреза со сменными пластинами кромочная прямая

D	H	d	Ф
19	30	8MM	
19	40	8MM	
21	50	12MM	
21	63,5	12MM	

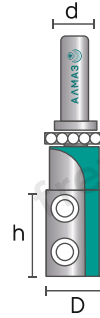
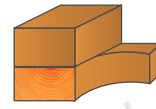

121 Фреза со сменными пластинами кромочная прямая

D	H	d	Ф
19	30	8MM	
19	40	8MM	
21	50	12MM	
21	63,5	12MM	

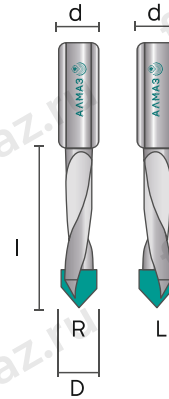

1004 Фреза под присадочный станок

D	l	d	Ф
5R	35	10MM	
5L	35	10MM	
6R	35	10MM	
6L	35	10MM	
8R	35	10MM	
8L	35	10MM	
10R	35	10MM	
10L	35	10MM	

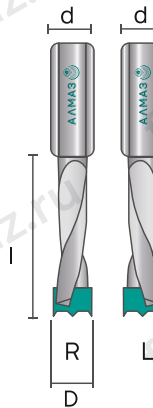

1011 Фреза под присадочный станок

D	l	d	Ф
4R	35	10MM	
4L	35	10MM	
5R	35	10MM	
5L	35	10MM	
6R	35	10MM	
6L	35	10MM	
8R	35	10MM	
8L	35	10MM	
10R	35	10MM	
10L	35	10MM	



10-s1 Фреза по алюминию

L	D	l	d	Ф
80	5x20	40	8MM	
100	5x30	60	8MM	
120	5x40	80	8MM	

ФРЕЗЫ

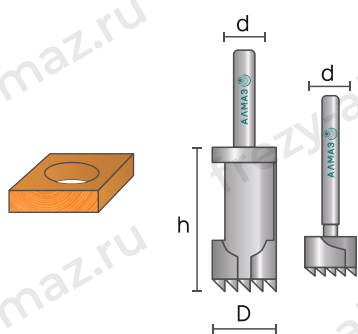

Пробочник

D	H	Р
8	56MM	
10	56MM	
12	56MM	
15	56MM	
20	56MM	
25	56MM	

Подшипник

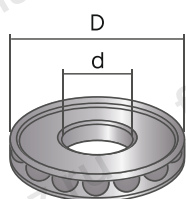

d	D	H	Р
3	6	2,5MM	
4	10	4MM	
4	12	4MM	
4,7	9,5	3MM	
4,7	12,6	5MM	
5	9	3MM	
5	10	4MM	
5	13	4MM	
5	14	5MM	
5	16	5MM	
8	12	5MM	
8	14	5MM	
8	16	5MM	
8	19	6MM	
8	22	7MM	
8	24	8MM	
8	28	8MM	
12	21	5MM	

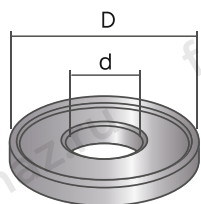

Стоп. кольцо

d	D	H	Р
8	16	5MM	
12	16	6MM	

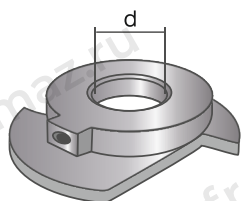

Стоп. кольцо 1011

d	Р
12	



1000s Фреза прорезная цельнопобедитовая

Z	D	H	d	Р
2	3	12	8MM	
2	4	15	8MM	
2	5	17	8MM	
2	6	22	8MM	
2	7	25	8MM	
2	8	30	8MM	
2	10	32	8MM	
2+2	8	30	8MM	
2+2	12	42	8MM	
3	16	55	16MM	
3	16	95	16MM	



Зенкер

D	H	d	Р
10	12,7	2,8MM	
10	12,7	3MM	
10	12,7	3,2MM	
10	12,7	3,5MM	

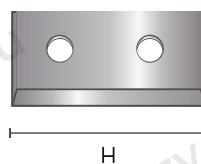

Пластины

H	L	Р
30	12	
40	12	
50	12	
63,5	12	

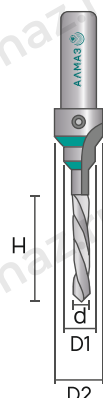

Конфирмат сверло

S	D1	D2	H	d	Р
10	6,5	10	40	4MM	
10	6,5	10	40	4,5MM	
10	7	10	40	5MM	
10	7	10,5	60	5MM	



Качество в каждой детали

Отсканируй QR-код чтобы получить больше информации, или перейди по ссылке

frezy-almaz.ru/nav